



**Operator Manual**

**Thermal Printer  
C-56**

**E**

**Release**

Release	1.0	
C.Bernhart	Mar 03 <sup>th</sup> , 2005	
Approved Hengstler	E.Link	
Approved		

**Changes**

Date	Rev	Additional Content
09 Nov 2004	1.0	First Release
03 Jun 2005	1.1	RS 232 extension
26 Jul 2005	1.2	Update technical data, troubleshooting
17 Jul 2006	1.3	Update USB cable spec; add safety hint
21 Jan 2008	1.4	Update spare parts; add EMC hints; adding sensor options
15 May 2009	1.5	Revise EMC specs.
5 Aug 2009	1.6	Add 12 volt specs, chute sensor, hardware PPE sensor. Add reference to short chute shroud.
17 Oct 2011	1.7	Add limitation on reversing paper. Added German paper specification. Removed reference to German operating manual with wrong P/N.
3 Apr 2013	1.8	Clarify serial pinout; add wiring diagram for serial connection cable; correct height-width-depth abbreviations; modified warning definition;
30 Jul 2015	1.9	Addition of chapter 2.3 and power supply pinout; various minor corrections
24 April 2018	2.0	Addition of hint for DC supply cable length

© 2005 - 2018 by **HENGSTLER**

This document is protected by copyright by HENGSTLER GmbH.

This document may not be changed, altered, duplicated or reproduced in any manner, or provided or transmitted to any third persons or organizations, without the prior written approval of HENGSTLER.

We reserve the right to make technical changes, modifications or improvements without prior notice.

Hengstler and the Hengstler logo are registered trademarks of Hengstler GmbH. Other brand and product names used herein are trademarks or registered trademarks of their respective companies.

**HENGSTLER GmbH**

Uhlandstr. 49  
 78554 Aldingen / Germany  
 Tel. +49 (0) 7424-89 0  
 Fax +49 (0) 7424-89 500  
 eMail: info@hengstler.com  
 www.hengstler.com

## Contents

	RELEASE.....	2
	CHANGES.....	2
<b>1.0</b>	<b>Introduction.....</b>	<b>4</b>
1.1	ADDITIONAL LITERATURE.....	4
<b>2.0</b>	<b>Important Information and Safety Instructions.....</b>	<b>5</b>
2.1	GENERAL INFORMATION.....	5
2.2	SYSTEM-SPECIFIC SAFETY INSTRUCTIONS AND SYMBOLS.....	5
2.3	PRINTER INSTALLATION.....	6
<b>3.0</b>	<b>Layout and Function.....</b>	<b>7</b>
3.1	STRUCTURE OF THE C-56 THERMAL PRINTER.....	7
3.2	FUNCTIONS OF THE PRINTER.....	8
<b>4.0</b>	<b>Operation.....</b>	<b>10</b>
4.1	START UP OF THE SYSTEM.....	10
4.2	LOADING OF PAPER.....	10
<b>5.0</b>	<b>Troubleshooting.....</b>	<b>11</b>
5.1	CLEARING PAPER JAMS.....	12
5.2	REPLACEMENT OF COMPONENTS.....	13
<b>6.0</b>	<b>Technical Data.....</b>	<b>14</b>
6.1	GENERAL DATA.....	14
6.2	CONFIGURATION OF THE INTERFACES.....	15
6.3	PAPER SPECIFICATIONS.....	16
6.4	DATA SPECIFIC TO PRINTING.....	16
6.5	ORDER NUMBERS FOR SPARE MODULES:.....	16

## 1.0 Introduction

Thank you for selecting the Hengstler C-56 printer! We are proud of this feature-rich product, which was designed using all our expertise and experience, and we are confident that you will be pleased with the advanced features and outstanding performance.

This Operator Manual is designed to help you with the proper installation, connection to your host computer system and start-up of the C-56 thermal printer system. All necessary details will be further explained in the following sections. Please read this manual carefully before starting up the thermal printer. If you have any further questions, please do not hesitate to contact our head office or one of our branch offices.

The thermal printer does not require any servicing and is intended primarily for printing documents and receipts, at a printing speed up to 220 mm/sec for the 24 VDC version, and up to 160 mm/sec for the 12 VDC version, when powered by an appropriate power supply and when printing on endless thermal paper with paper weight ranging from 50 to 60 g/m<sup>2</sup>. The paper width may vary from 58 to 60 mm (2.28" to 2.36"). While documents may be any length greater than 120 mm, most documents will fall in the range of 120 to 297 mm.

The horizontal and vertical print density is 203 dpi so that graphics, such as logos etc. can be printed with good quality.

The printer mechanism has been designed in particular for application in self-service gasoline pumps in service stations, in terminals and vending applications. The modular design enables the main components to be replaced in less than 2 minutes. The controller integrated in the printer mechanism controls all printing functions and is provided with an USB 1.1 port for the host computer. Driver software is available that supports the Windows XP/7/8/10 and Linux operating systems. In addition, the printer can also be activated directly in ASCII mode through ESC/FS sequences; a detailed description of the different sequences is contained in the Emulation Manual.

### 1.1 Additional Literature

C-56 Emulation Manual	D 684 017
Paper Specification (English)	D 684 012
Paper Specification (German)	D 684 010
Dimensional Drawing	D 684 048 etc; see the C-56 download area at <a href="http://www.hengstler.de">www.hengstler.de</a>

## 2.0 Important Information and Safety Instructions







### 2.1 General Information

The company Hengstler GmbH will not accept any liability for direct or consequential damages arising due to improper use of the thermal printer and, in particular, due to non-compliance with this operating manual or to improper handling and maintenance. The supply of technical documentation does not imply any authorization by Hengstler GmbH to make additions, repairs or modifications.

This documentation may not be copied, nor shall its contents be disclosed or used commercially unless this has otherwise been explicitly agreed. The user is responsible for proper handling and installation of the printer. The printer should only be shipped in its original packing.

### 2.2 System-Specific Safety Instructions and Symbols

Hengstler GmbH will not accept any liability for the safe operation of the C-56 thermal printer unless Hengstler original products are used exclusively and the following instructions and recommendations are heeded.

-  If unauthorized persons perform any repairs or modifications to the printer mechanism and the controller, HENGSTLER will not accept any liability and the guarantee shall be void.
-  Unapproved types of thermal paper may dramatically reduce the life of the print head and may void the guarantee. For pre-printed thermal paper make sure that only appropriate inks are used. Details can be found in the Hengstler Paper Specifications D 684 012.
-  The connector for the power supply must not be plugged in or disconnected under load in order to avoid damage to the electrical components and the thermal printhead.
-  Avoid strong vibration, shocks and impacts since they may damage or even destroy sensitive electronic and mechanical components. Do not touch the surface of the printer control board in order to prevent static electricity from damaging sensitive components.
-  The thermal printer must not be used near to high-frequency apparatus or strong magnetic fields in order to prevent undefined magnetic disturbance.
-  Do not make any attempts to service this printer (e.g. change paper) while the printer is printing.
-  Installing or uninstalling the printer must only be done while using adequate ESD protection.

The following symbols on the system and in the manual remind you to follow the relevant safety instructions:



General warning for cases where the user or service personnel may be in danger.



General notes and hints for operating the system safely.

### 2.3 Printer Installation

The C-56 printer uses electrically conductive housing materials which help to eliminate electrostatic charging during printing. In order to protect the printer from damages caused by externally applied charges, e.g. when electrostatically charged customers grab the receipt at the printer chute, the printer must be grounded.

The mounting holes of the printer's base unit can be utilized for this where a ground wire with lug may be inserted in one of the two screw points.

If the printer is mounted in an electrically conductive and already grounded panel, additional wiring can be omitted if sufficient electrical contact is ensured through the mounting points.



**Caution:**

The C-56 printer mounting must ensure permanent electrical connection of the printer's base unit to ground. This measure serves the draining of externally applied electrostatic charge.

### 3.0 Layout and Function

All modules of the C-56 thermal printer mechanism are delivered in operating condition. After connecting the printer to a USB 1.1 or 2.0 port on the host system (PC) and to a properly rated 24 VDC or 12 VDC power supply (depending upon the model), and installing the driver software (if needed), the printer is ready for operation.

- ☞ This thermal printer is a built-in module to be operated only as part of an overall system like e.g. a vending application. Please, also consider the storage and operating conditions (see also under chapter 6 - Technical Data).

### 3.1 Structure of the C-56 Thermal Printer

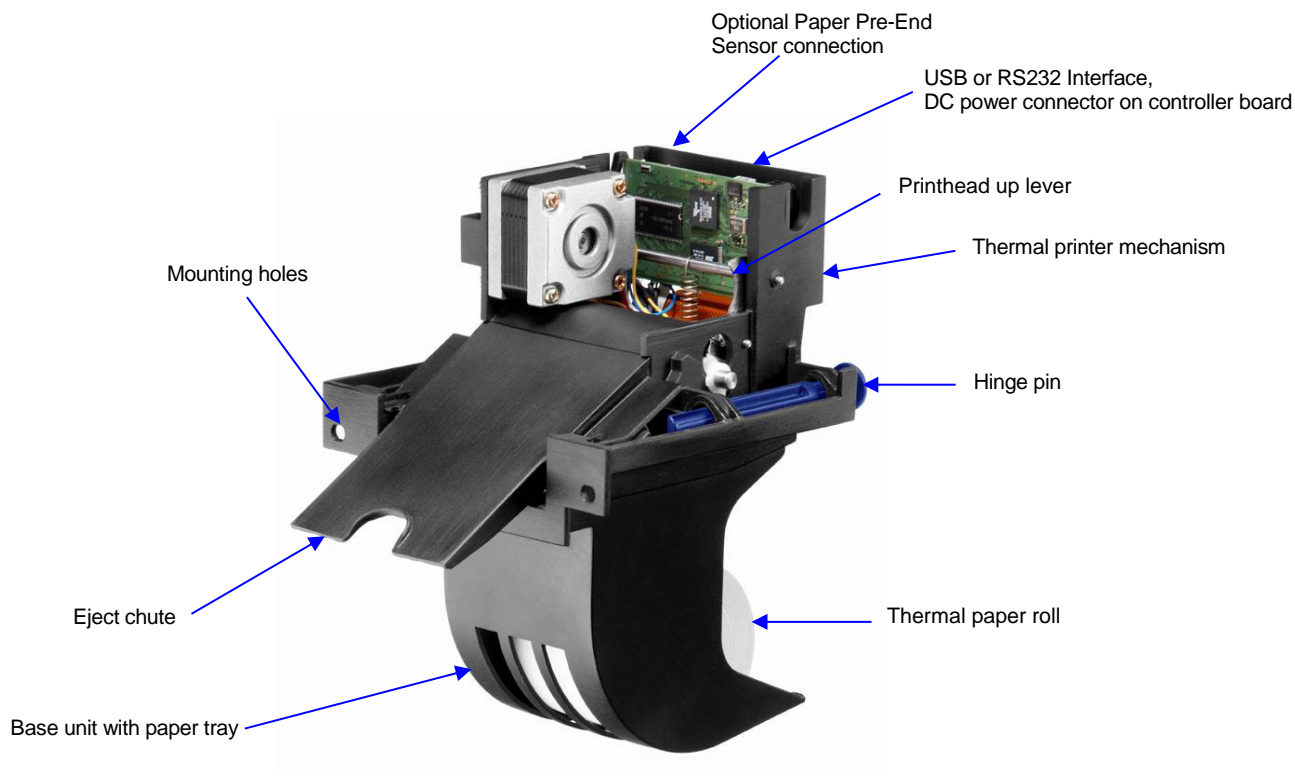

Fig.1 Thermal printer, front view left hand

The C-56 Thermal Printer is composed of three main units: thermal printer with integrated Controller, basic unit with paper tray and two hinge pins, and an eject chute supported by the basic unit. These hinge pins secure the printer mechanism on the basic unit. If both hinge pins are retracted in part, the printer mechanism can be removed. If only one hinge pin is retracted, the printer mechanism can be pivoted around the remaining hinge pin.

The Eject Chute is provided with guides that engage in the basic unit firmly and with high dimensional accuracy. The paper roll lies in the paper tray loosely. The sensitive side of the thermal paper must be outside or be directed upward.

- ☞ Note: A shorter Eject Chute is also available for OEM applications. When this shorter chute is used, an external, customer-supplied shroud **must** be used! Failure to use this shroud will cause increased paper jams. Contact Hengstler for details of the shroud design.
- ☞ In Fig. 1, the protective plastic cover has been removed (also see Fig. 2) to provide a view of the controller board. But for operation, this plastic cover must be in place.

### 3.2 Functions of the Printer

The printhead of the C-56 printer mechanism has a horizontal resolution of 203 dpi (dots per inch). Thus, the 448 dots allow printing of lines with a maximum width of 56 mm. The stepper motor affects the paper feed by means of a platen that is rotated via gearing. The transmission ratio of this gearing has been selected in such a way that the vertical dot resolution is also 203 dpi; this corresponds to a paper movement of 0.125 mm. All functions of the printer mechanism are controlled by the integrated Controller.

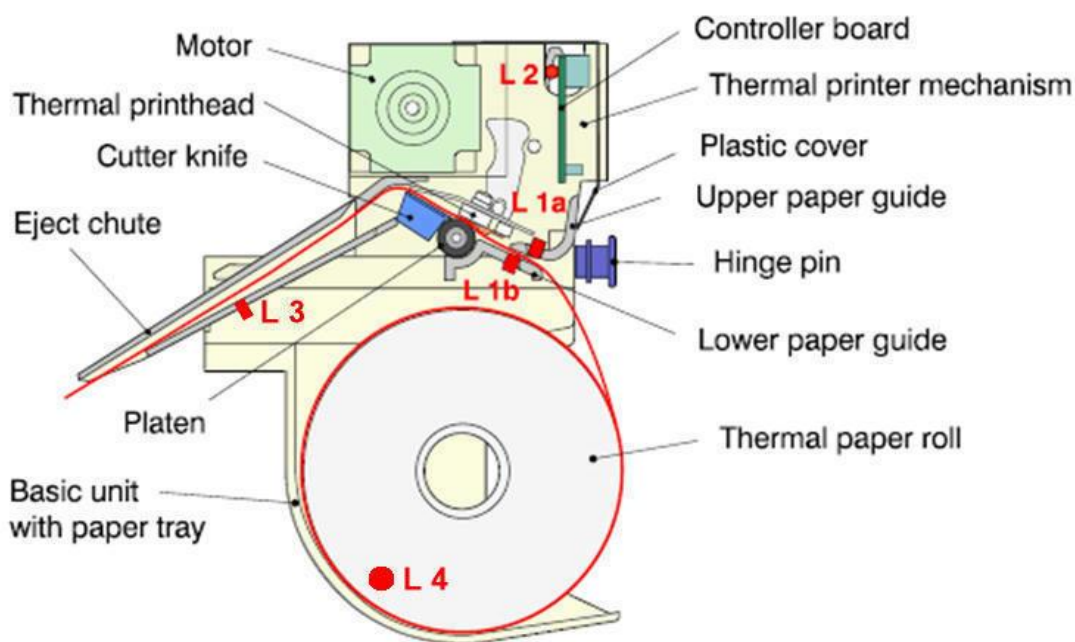

Fig. 2 Diagram of paper transport

The paper is inserted into the printer through the upper and lower paper guides and led over the platen. As soon as the reflective LED sensor **L1a** in the upper guide detects the front paper edge, 'automatic paper insertion' will start and the paper is transported until its front edge can be seized in the eject chute. The LED **L2** signals that the printer is ready by flashing slowly.

- ☞ In the event the paper edge is not detected within approximately 5 seconds, the printer will assume a malfunction and LED **L2** (on the component side of the controller board) will flash rapidly, indicating 'No paper/paper end'. The paper loading process is then aborted and must be repeated.

As an alternative, the reflective LED sensor **L1b** may be installed instead of the sensor **L1a**. It will detect the paper edges and recognize position identification marks (Black Marks) on the back side of the paper. The ejected paper is cut when the user pulls it from the printer, thereby tearing it straight over the cutter. The shape of the triangle cutter knife provides for a clean cut. The further paper transport will be carried out by program control.

Optional reflective LED sensor **L3** detects the presence of paper in the eject chute. The status of **L3** can be determined via the Query command and is reported as part of the C-56 status bytes. See the C-56 Emulation Manual D 684 017 for details on querying this sensor and the format of the response.



Optional reflective LED sensor **L4** is located on the left outside of the paper reservoir and detects when the diameter of the paper roll decreases below a fixed dimension, indicating that paper is low. This is a hardware alternative to the default paper low system, which requires thermal paper with black marks at the end of the paper roll. The status of **L4** can be determined via the Query command and is reported as part of the C-56 status bytes. See the C-56 Emulation Manual D 684 017 for details on querying this sensor and the format of the response.



In case of any trouble during paper feed, the printhead can be lifted from the platen manually using the “printhead up” lever so that the paper can be pulled out of the printer mechanism.

**Caution !**

Do not lift the printhead during printing or the thermal printhead may be damaged or destroyed by overheating.

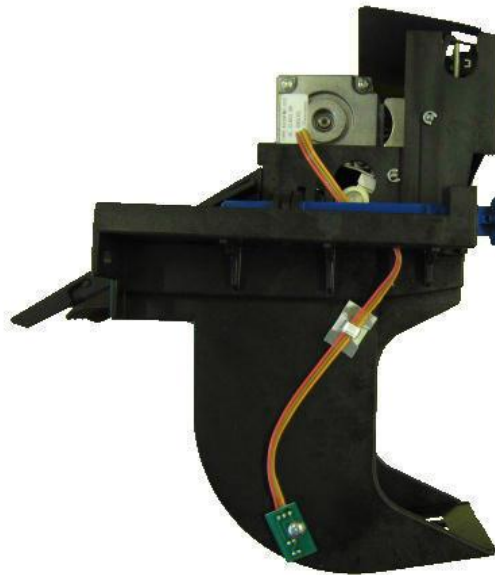

Fig. 2a C-56 with Hardware Paper Low Sensor

## 4.0 Operation

Once the C-56 thermal printer is connected to the power supply and the host's interface port, and the driver (if needed) is installed, the printer is ready for use.

### 4.1 Start up of the System

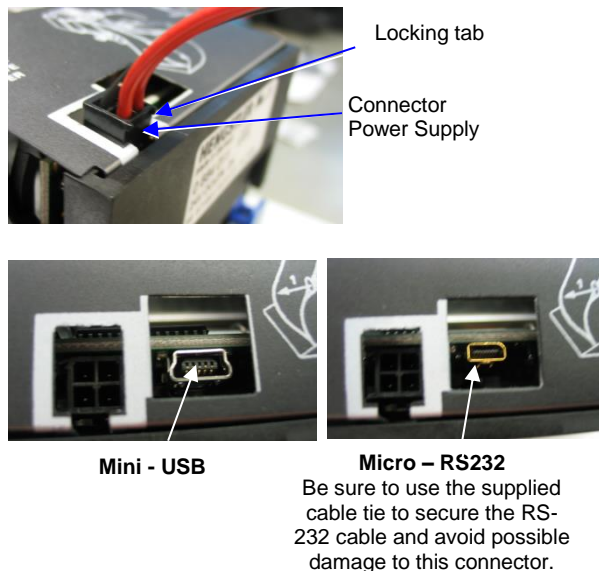

Fig. 3 Connections of the thermal printer to the system

1. The connection to power supply is to be done exclusively by means of the supplied cable. Make sure that the power supply is always switched off before the connector is plugged in or removed. The locking tab of the connector should always be directed towards the paper insert side.
2. Connect the a) mini - USB port of the printer mechanism with a USB – interface, or b) micro - RS232 port with a RS232 interface of your PC, using the supplied USB / RS232 cable. On USB, Windows will then automatically recognize the new connected device and install the appropriate driver software.
3. Install the driver software on the host system (PC). Please, consider the coordination of the drivers with the operating systems and respect the current instructions supplied together with the drivers.

### 4.2 Loading of Paper

-  Please only use paper of the recommended quality. Thermal paper with other specifications or poorer quality may reduce the service life of the thermal printhead considerably and will invalidate the printer's warranty.



Fig. 4 Loading of the paper roll

1. Pull the protective sheathing from the paper roll and cut the paper end at right angles to the direction of feed as far as possible. Truncated, lacerated or folded paper edges can produce a paper jam during automatic insertion. Also perforations of the paper web or rounded edges are not acceptable.
2. Lay the paper roll into the paper tray as shown in the illustration. The thermal sensitive paper surface must be situated outside or on top.
3. Insert the paper into the printer mechanism. As soon as the sensor in the paper guide detects paper, the controller starts the automatic paper insertion.
4. Cut off the paper appearing in the eject chute by pulling it straight out.

## 5.0 Troubleshooting

The paper path in the printer mechanism is almost straight so that proper paper feed and guiding will prevent paper jams (see also Fig. 2). The following malfunctions if any will be recognized and signaled by the integrated controller:

<b>Paper Insert Error</b>	<p>In case the 'Automatic Paper Insertion' starts, but the paper has been held back by hand too long time or has been fed in skewed, the paper path can indicate a 'Paper Insert Error' caused by a time out of the sensor routine. As <b>failure corrective action</b>, pull the paper back. In case the paper has already been transported by the platen, left the printhead, pull back the paper and restart the loading procedure.</p>
<b>No Paper Insertion</b>	<p>In case the 'Automatic Paper Insertion' does not start and the motor stalls, with a characteristic rattling sound. If the printer has been left with no paper inserted for a longer period (e.g. a day or more), the printhead can cause a temporary depression of the platen and the motor will not start turning. Lift the printhead using the head lift lever (see Fig. 5) and insert paper. Release the head lift lever after the motor begins to run smoothly and the platen begins to pull the paper. Continue the auto loading procedure.</p>
<b>Paper Jam</b>	<p>During operation, a paper jam may occur in the eject chute due to paper scraps, etc. Jamming may also occur from reversing the paper for more than the 150 mm specified maximum reverse distance. As <b>failure corrective action</b>, tilt the printer mechanism open and remove any paper scraps found at the entrance into the eject chute. In case the eject chute has been clogged deliberately (vandalism), the chute will have to be dismantled and cleaned. Afterwards repeat the paper loading routine.</p>
<b>Paper End</b>	<p>The sensor L1 (a or b, depending upon the variant of sensor placement) will detect the end of the paper, e.g. in case of a torn paper web. As <b>failure corrective action</b>, remove the document that has already partly been printed (see Paper Jam) and repeat the paper loading routine. If necessary, load a new paper roll.</p>
<b>Paper Pre-End</b>	<p>The sensor L1 recognizes the 'paper pre-end mark' so that the controller can transmit the status message 'Paper Pre-End' upon receipt of the Query Status command. Alternatively, if so equipped, sensor L4 will detect that the paper roll diameter has decreased to the point that it is no longer reflecting the side of the paper roll when in the rest position, and will transmit the 'Paper Pre-End' status message when queried. In either case, the printing of further documents will not be blocked unless the printer detects 'Paper End'. A new loading operation will cancel this message.</p>
<b>Undefined Error</b>	<p>In case none of the above mentioned failures is detected, the printer may be blocked by the operating system because e.g. the printer is not recognized by the PC. If no other obvious disorder of the operating system is found, we recommend as <b>failure corrective action</b> to disconnect the USB cable from the PC. The operating system will then deactivate the driver software. Re-establish the USB connection after an interruption of about 1 minute in order to re-activate the driver software.</p>

## 5.1 Clearing Paper Jams

In order to clear a paper jam, detach the document that is already present in the eject chute and retract the remaining paper manually. Paper scraps remaining in the area between the print mechanism and eject chute can be removed after the printer is tilted open.

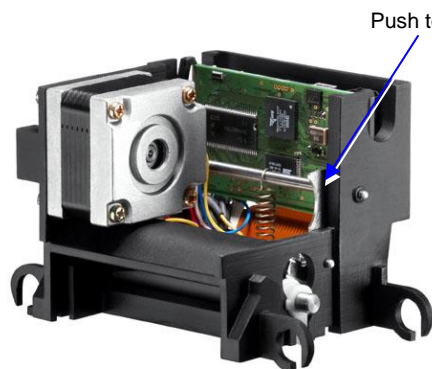

In case there is still paper between the printhead and the platen, remove the friction between head and platen by pressing down the lever and then pull the paper back by hand.



Never actuate this lever during the printing operation or else the printhead will overheat.

Fig. 5 Open paper path for removing paper

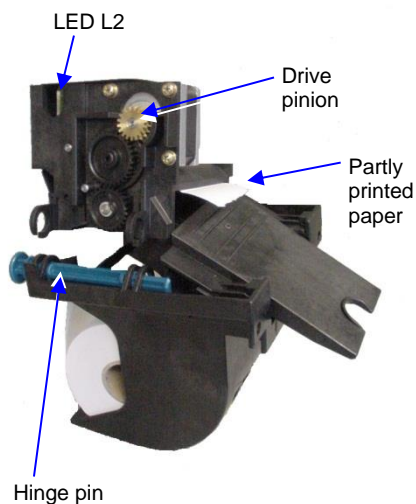

If a partly printed document remains in the printer mechanism, e.g. in the event of a paper end signal due to a tear, and it does not appear in the eject chute, the printer mechanism will have to be tilted open and the document be taken out by hand. Note that additional care must be taken concerning wire routing if the optional chute sensor or hardware paper-low sensor are installed.

1. Pull the hinge pin back into its tilt position.
2. Then tilt the printer open as illustrated. Now, the partially printed document will be visible and can be pulled out over the eject chute.
3. Eject the document by twisting the motor pinion gear clockwise until the document leaves the friction area of the platen.
4. Remove the partially printed document. Then again tilt the printer mechanism back into its operating position and secure it by snapping the hinge pin into its operating position.

Fig. 6 Tilt the printer mechanism open for paper removal

## 5.2 Replacement of Components

The C-56 thermal printer does not require any servicing. It has been designed such that its main modules represented in the illustration below can be replaced also by the operational staff after short briefing, within less than 2 minutes. The modules do not require any adjustment. Note that additional care must be taken concerning wire routing if the optional chute sensor or hardware paper-low sensor are installed.



Fig. 7 Modular structure of the C-56 thermal printer with 4 main components

The eject chute is pushed into the guiding supports on the basic unit and cannot be removed when the printer mechanism is installed. It represents the only access to the printer for the customer. The hinge pins are inserted into the collars onto the basic unit in the sense illustrated above and then are pushed against the tilt position. Only in this position, the printer mechanism can be placed onto the basic unit, and when the hinge pins are snapped into the operating position, the printer will be locked on the basic unit. The two holes on the front of the basic unit serve for installing the C-56 thermal printer in vending applications etc.

## 6.0 Technical Data

### 6.1 General Data

<b>Dimensions:</b>	Height-width-depth HxWxD (in mm): 184.5 x 129.5 x 169.5 For opening the printer, a free space of height H = 45 mm and width W = 60 mm must be provided. Please refer to the dimensional sheets at <a href="http://www.hengstler.com">www.hengstler.com</a> .
<b>Weight:</b>	Net approx 0.56 kg
<b>Operating Voltage:</b>	+24 VDC $\pm$ 5 %, SELV (EN60950) Optional +12 VDC $\pm$ 5 %, SELV (EN60950) Current consumption stand by 0.1 A, operation up to 6 A Recommended safety fuse: 6 A, delayed-action  DC supply cable length < 3 meters No DC building power supply; compare warnings on next page
<b>UL - Certificate:</b>	E174318
<b>Interface:</b>	a) Mini USB 1.1 industrial; cable length < 3 meters Transmission rate: 1.5 MBit/s and 12 MBit/s Printer graphics driver for Windows XP/7/8/10 and LINUX USB – interface cable  b) Micro RS232; cable length <3 meters Communication protocol: Hardware DTR/CTS, None Baud Rate: 4800, 9600, 19200, 38400, 57600, 115200 (default) Parity: Off (default), On Data Bits: 8 Stop Bits: 1 (default), 2 RS232 – interface cable
<b>Noise Level:</b>	< 55 dB(A) according to ISO 3744
<b>Operating Conditions:</b>	For guaranteed printing quality (limit values in brackets) Temperature: +5 °C to +50 °C (- 30°C to + 70 °C) Humidity: 20 % to 80 % (90 %), no condensation
<b>Storage Conditions:</b>	Temperature: -40° C to + 85° C Humidity: 5 % to 95 %, condensation not permitted  During storage and storage in transit, leave paper inserted between thermal printhead and platen
<b>Operating Reliability:</b>	Printer mechanism: 100 km of paper, at a printing density of 12.5% or 100 million dot pulses MTTR: 1.5 minutes (module exchange) All data refer to processing of the recommended paper quality, in a temperature range appropriate to yield the guaranteed printing quality.

**EMC:** EN55022 - Emission  
 Warning! The C-56 thermal printer is a class "A" appliance.  
 It can produce radio interference in residential areas so that the user may be forced to take adequate remedial measures.

EN55024 - EMS Immunity  
 Electrostatic discharges and burst effects may cause short printing interruptions. But the automatic recovery function will restore the original state of the thermal printing mechanism.



Additional action regarding lightning and overvoltage protection will be needed, if cables and wires are installed outside of a building.



However, this standard can be met only if original units, components, and cables are applied and the installation instructions are respected.



When operating the printer from a DC building power supply, or when the DC power cable exceeds 3 meters in length, appropriate EMI filters must be used.

External interference caused by ESD or EMI can temporarily cause corrupted printing or data loss.

**6.2 Configuration of the Interfaces**

USB 1.1 Interface

Type A (PC Side)	Signal Name	mini-B (C-56 Side)
1	+5V	1
2	D +	2
3	D -	3
4	GND	5
Metal housing	Shield	Metal housing

Note: +5V is only connected in special versions

RS 232 Interface

8-pin micro (C-56 Side)	Signal Name (C-56)
1	RxD
2	TxD
3	CTS
4	RTS
5	GND
6	GND
7	GND
8	N/C
housing	shield

Power supply

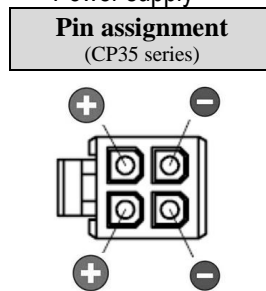

## Wiring of the C-56 Serial Cable P/N 0684103

8-pin micro (C-56 Side)	Signal Name (C-56)	Connection	9-pin Sub-D (PC side)	Signal Name (PC side)
1	RxD	↔	3	TxD
2	TxD	↔	2	RxD
3	CTS	↔	7	RTS
4	RTS	↔	8	CTS
5	GND	N/C	4 (jumpered to 6) 6 (jumpered to 4)	DTR
6	GND	N/C		DSR
7	GND	↔	5	GND
8	N/C	N/C	1, 9	N/C
housing	shield	↔	shell	shield

### 6.3 Paper Specifications

**Recommended Paper Quality:** Thermal papers 50 to 60 g/m<sup>2</sup>; thermosensitive surface on outside; see Paper Specification D 684 012

**Converting:** Paper roll      Roll width: 58 to 60 mm (2.28" to 2.36")  
 Roll diameter: up to 100 mm (4")  
 Typical: 75 mm (3") or 100 mm (4")

The paper pre-end mark is to be printed on the coated paper side. For further data regarding the printing of pre-end marks or 'Black Marks' please refer to the Paper Specifications D 684 012.

### 6.4 Data specific to Printing

Designation	Specification
Printing method	Thermal direct
Number of dots	448
Dot Resolution (horizontal resolution)	8 Dots/mm (203 dpi)
Paper Transport (vertical resolution)	0,125 mm / Dotline (in accordance with the horizontal resolution)
Max. Printing Width	56 mm
Printing Speed	Up to 220 mm / sec (24 VDC) or 160 mm / sec (12 VDC)
Paper Width	58 mm (2,28") to 60 mm (2,36")
Length of document	120 mm up to endless
Maximum Reverse Paper Distance	150 mm; longer may lead to paper jams
Chute Sensor	Optional chute sensor
Paper Pre-End Detection	Printing mark onto the topline Optional hardware paper pre-end sensor
Printhead Temperature Monitoring	Thermistor
Workload	Max. 20 documents / min. (at 120 mm paper length)

### 6.5 Order Numbers for Spare Modules



---

Thermal Printer mechanism RS232	E2684001
Thermal Printer mechanism USB	E2684002
Paper tray (contains 10 pieces)	E2684009
Eject chute standard (contains 10 pieces)	E2684005
Eject chute short (contains 10 pieces)	E1684019
Hinge pin (contains 10 pieces)	E2684012
DC power supply cable	E1684009
USB Data Cable	0684102
RS232 Data Cable	0684103